

A 145 BOB - A 145

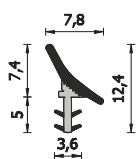

Modelli alternativi: A 230 BARRA DOPPIA
 Scatole da 435 m Bobine da 350 m
 Colori: marrone - bianco - beige
 Bobina con separatore di carta
 Alternative models: A 230 BARRA DOPPIA
 435 m boxes 400 m coils
 Colours: brown - white - hazel brown
 Coil with paper separators

A =	-	B =	8 mm
C =	5 mm	D =	3 mm

A 170 BOB - A 170

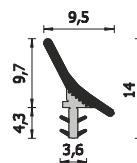

Modelli alternativi: A 204 BARRA DOPPIA
 Scatole da 377 m Bobine da 300 m
 Colori: marrone - bianco - beige
 Bobina con separatore di carta
 Alternative models: A 204 BARRA DOPPIA
 377 m boxes 300 m coils
 Colours: brown - white - hazel brown
 Coil with paper separators

A =	-	B =	10 mm
C =	5 mm	D =	3,2 mm

A 204X260 - A 204X215

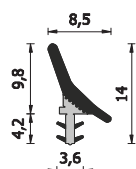

Scatole 390 m Imb W09 (75 pezzi in 2 barre - doppio unito - da 2,6m) o da 322,5m (75 pezzi in 2 barre - doppio unito - da 2,15m) Imb W08
 Colori: marrone - bianco - beige
 Boxes 390m W09 Pkg (75 pieces in 2 bars - double and jointed - 2,6m each) or 322,5m (75 pieces in 2 bars - double and jointed - 2,15 m each) W08 Pkg
 Colours: brown - white - hazel brown

A =	-	B =	10 mm
C =	5 mm	D =	3,2 mm

A 230X260 - A 230X215

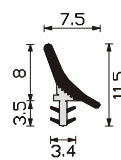

Scatole 390 m Imb W09 (75 pezzi in 2 barre - doppio unito - da 2,6m) o da 322,5m (75 pezzi in 2 barre - doppio unito - da 2,15m) Imb: W08
 Colori: marrone - bianco - beige
 Boxes 390m W09 Pkg (75 pieces in 2 bars - double and jointed - 2,6m each) or 322,5m (75 pieces in 2 bars - double and jointed - 2,15 m each) W08 Pkg
 Colours: brown - white - hazel brown

A =	-	B =	8 mm
C =	5 mm	D =	3 mm

A 219/15 - A 219/10

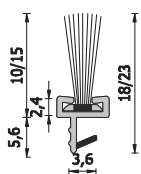

Spazzolino altezza 10mm (Scatole 260 m Imb W06 - Scatole 215 m Imb W07) o 15mm (Scatole 260 m Imb W09 - Scatole 215 m Imb W08)
 Colori: marrone - bianco - beige - grigio - nero
 Pile: height 10mm (260m boxes W06 Pkg - 215m boxes W07 Pkg) or height 15mm (260m boxes W09 Pkg - 215m boxes W08 Pkg)
 Colours: brown - white - hazel brown - grey - black

A =	-	B =	-
C =	7 mm	D =	3,2 mm



Esempio di installazione con utilizzo dei diversi articoli:

Sezione orizzontale

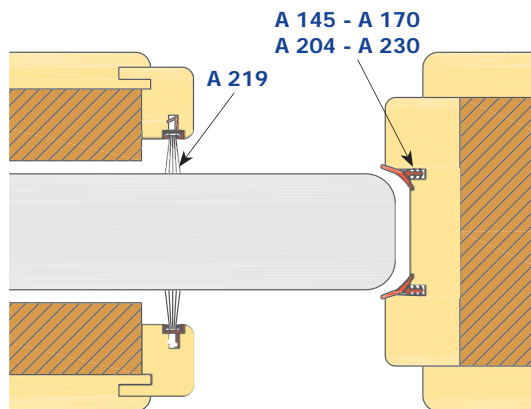

Sezione verticale

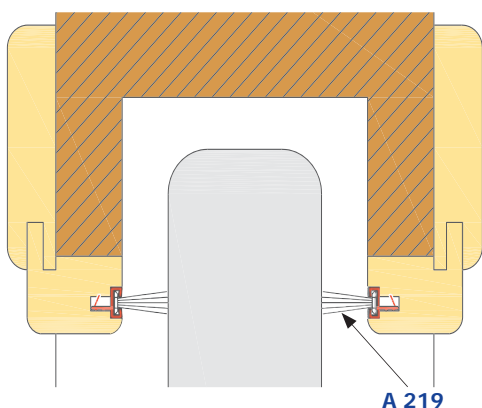

PER PORTE SCORREVOLI SONO DISPONIBILI ANCHE I KIT PER SINGOLA INSTALLAZIONE CONFEZIONATI IN BLISTER.

COD. KITSCO15__ con spazzolino da 15 mm
 COD. KITSCO10__ con spazzolino da 10 mm

Per il colore aggiungere in fondo al codice:

- BC (BIANCO)
- NR (NERO)
- MN (MARRONE)
- NN (BEIGE)
- BG (GRIGIO)



A 393x220

Scatole da 308 m Imb W07
Colori: nero

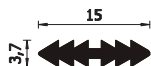

308 m boxes W07 Pkg
Colours: black

A =	-	B =	-
C =	-	D =	-

A 396x220

Scatole da 198 m Imb W07
Colori: nero

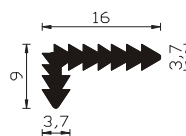

198 m boxes W07 Pkg
Colours: black

A =	-	B =	-
C =	-	D =	-

A 397x220

Scatole da 440 m Imb W07
Colori: nero

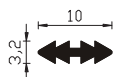

440 m boxes W07 Pkg
Colours: black

A =	-	B =	-
C =	-	D =	-

AL 92

Profilo in alluminio
Scatole da 200 m

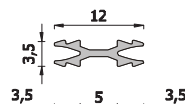

Aluminium profile
200 m boxes

A =	-	B =	-
C =	-	D =	-

AL 93

Profilo in alluminio
Scatole da 200 m

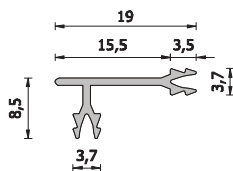

Aluminium profile
200 m boxes

A =	-	B =	-
C =	-	D =	-

A 458x220

Scatole da 308 m Imb W07
Colori: nero

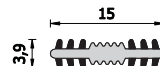

308 m boxes W07 Pkg
Colours: black

A =	-	B =	-
C =	-	D =	-

Esempio di installazione con utilizzo dei diversi articoli:

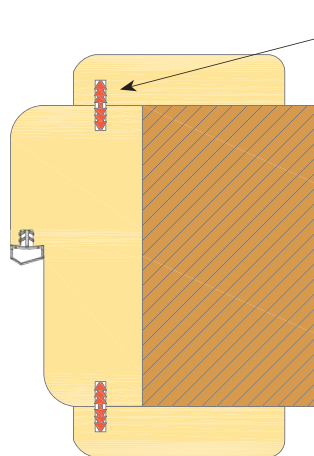

A 393 - A 458 -
A 397 - AL 92

[Sezione orizzontale](#)

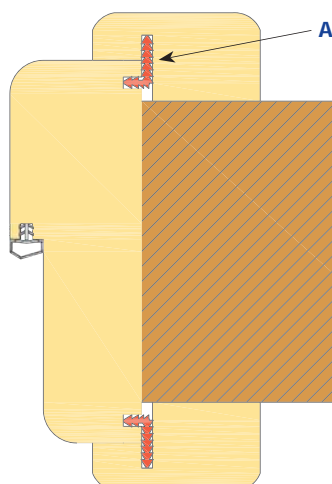

A 396 - AL 93

[Sezione orizzontale](#)



Bobina